



POWERING INNOVATION THAT DRIVES HUMAN ADVANCEMENT

© 2025 ANSYS, Inc. or its affiliated companies
Unauthorized use, distribution, or duplication is prohibited.

Getting Started with EMIT - Tutorial 2



ANSYS, Inc.
Southpointe
2600 Ansys Drive
Canonsburg, PA 15317
ansysinfo@ansys.com
<https://www.ansys.com>
(T) 724-746-3304
(F) 724-514-9494

Release 2025 R2
July 2025

ANSYS, Inc. and
ANSYS Europe,
Ltd. are UL
registered ISO
9001:2015 com-
panies.

Copyright and Trademark Information

© 1986-2025 ANSYS, Inc. Unauthorized use, distribution or duplication is prohibited.

ANSYS, Ansys Workbench, AUTODYN, CFX, FLUENT and any and all ANSYS, Inc. brand, product, service and feature names, logos and slogans are registered trademarks or trademarks of ANSYS, Inc. or its subsidiaries located in the United States or other countries. ICM CFD is a trademark used by ANSYS, Inc. under license. All other brand, product, service and feature names or trademarks are the property of their respective owners. FLEXIm and FLEXnet are trademarks of Flexera Software LLC.

Disclaimer Notice

THIS ANSYS SOFTWARE PRODUCT AND PROGRAM DOCUMENTATION INCLUDE TRADE SECRETS AND ARE CONFIDENTIAL AND PROPRIETARY PRODUCTS OF ANSYS, INC., ITS SUBSIDIARIES, OR LICENSORS. The software products and documentation are furnished by ANSYS, Inc., its subsidiaries, or affiliates under a software license agreement that contains provisions concerning non-disclosure, copying, length and nature of use, compliance with exporting laws, warranties, disclaimers, limitations of liability, and remedies, and other provisions. The software products and documentation may be used, disclosed, transferred, or copied only in accordance with the terms and conditions of that software license agreement.

ANSYS, Inc. and ANSYS Europe, Ltd. are UL registered ISO 9001: 2015 companies.

U.S. Government Rights

For U.S. Government users, except as specifically granted by the ANSYS, Inc. software license agreement, the use, duplication, or disclosure by the United States Government is subject to restrictions stated in the ANSYS, Inc. software license agreement and FAR 12.212 (for non-DOD licenses).

Third-Party Software

See the legal information in the product help files for the complete Legal Notice for Ansys proprietary software and third-party software. If you are unable to access the Legal Notice, please contact ANSYS, Inc.

This instruction means that you should click the **Line** command on the **Schematic** ribbon tab. An image of the command icon, or a partial view of the ribbon, is often included with the instruction.

- The *menu bar* (located above the ribbon) is a group of the main commands of an application arranged by category such File, Edit, View, Project, etc. An example of a typical user interaction is as follows:

"On the **File** menu, click the **Open Examples** command" means you can click the **File** menu and then click **Open Examples** to launch the dialog box.

- Another alternative is to use the *shortcut menu* that appears when you click the right-mouse button. An example of a typical user interaction is as follows:

"Right-click and select **Assign Excitation> Wave Port**" means when you click the right-mouse button with an object face selected, you can execute the excitation commands from the shortcut menu (and the corresponding sub-menus).

Getting Help: Ansys Technical Support

For information about Ansys Technical Support, go to the Ansys corporate Support website, <http://www.ansys.com/Support>. You can also contact your Ansys account manager in order to obtain this information.

All Ansys software files are ASCII text and can be sent conveniently by e-mail. When reporting difficulties, it is extremely helpful to include very specific information about what steps were taken or what stages the simulation reached, including software files as applicable. This allows more rapid and effective debugging.

Help Menu

To access help from the Help menu, click **Help** and select from the menu:

- **[product name] Help** - opens the contents of the help. This help includes the help for the product and its *Getting Started Guides*.
- **[product name] Scripting Help** - opens the contents of the *Scripting Guide*.
- **[product name] Getting Started Guides** - opens a topic that contains links to Getting Started Guides in the help system.

Context-Sensitive Help

To access help from the user interface, press **F1**. The help specific to the active product (design type) opens.

You can press **F1** while the cursor is pointing at a menu command or while a particular dialog box or dialog box tab is open. In this case, the help page associated with the command or open dialog box is displayed automatically.

Table of Contents

Table of Contents	Contents-1
1 - Introduction	1-1
Key Concepts	1-1
Project Configuration	1-1
2 - Modify the Tx and Rx Samplings	2-1
3 - Run the Simulation	3-1

1 - Introduction

This tutorial builds on the project developed in Tutorial 1 to introduce additional modeling concepts and features in EMIT. You can load a completed version of the Tutorial 1 project archive from "C:\Program Files\ANSYS Inc\v252\AnsysEM\Examples\EMIT\Tutorials\Tutorial 1\Tutorial 1 - Completed", or you can work with your own version of the Tutorial 1 project.

Key Concepts

- Samplings with multiple channels
- Explore results and "drill-down" into Scenario Details
- Frequency Hopping with random sampling and EMIT's availability metric

Project Configuration

For this tutorial, we will modify the project built in Tutorial 1. Load that project into Electronics Desktop and save it as "Tutorial 2" by selecting Save As from the main File menu.

Delete the low pass filter on the Tx by right clicking the Filter in the EMIT Design's Schematic Diagram and selecting Delete. Reconnect the Antenna to the Tx-1 (Lo-VHF) radio.

2 - Modify the Tx and Rx Samplings

We want to modify the Tx and Rx radios so that we can explore the use of EMIT when a design contains multiple radios and multiple channels within a sampling.

To begin, open the Tx-1 (Lo-VHF) Radio's Configuration dialog and select the Sampling node. In the property panel, edit the Frequency Ranges table to have a single range from 30 MHz to 80 MHz. Since the Tx is defined with 1 MHz channel spacing, 51 separate Tx channels will be simulated.

Sampling Type: Uniform Sampling

Specify Percentage: False

Max # Channels/Range/Band: 1000

Total Tx Channels: 51

Total Rx Channels: 0

▼ Frequency Ranges

Min (MHz)	Max (MHz)
30	80

Insert Row Remove Selected Rows

EMIT can model radios that are operating in a frequency hopping mode by setting the Sampling Type to Random Sampling, which uses a pseudorandom number generator to randomly select a channel within the Frequency Range(s) defined for the Band. An EMIT design may contain any number of Radios and each radio can have unique sampling parameters.

To create a second radio for the Tx so that we can simulate its frequency hopping mode, right-click on the Tx-1 (Lo-VHF) radio in the schematic and select **Copy**. Paste the Radio into the schematic and rename it to *Tx-1 (Lo-VHF) Hopping*. In the property panel of its Sampling node, set the parameters as shown below. The radio will randomly "hop" on 10 of the available frequencies between 30 and 80 MHz, inclusive. If desired, multiple rows can be included in the table to allow a radio to hop in non-contiguous segments of a band.

Sampling Type: Random Sampling

Specify Percentage: False

Max # Channels/Range/Band: 10

Seed: 0

Total Tx Channels: 10



Total Rx Channels: 0

▼ Frequency Ranges

Min (MHz)	Max (MHz)
30	80

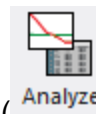
Insert Row Remove Selected Rows

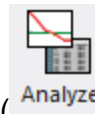

In the Simulation ribbon tab, click the Analyze button () to open the results dialog. Note that if you look at the Scenario Matrix in the top-left of the results dialog, Total Channel Combinations = 51 which is the number of channels in the Tx-1 (Lo-VHF) radio alone. That is because we have not yet connected this new radio (Tx-1 (Lo-VHF) Hopping) to an Antenna, and it will not be simulated. In the Schematic ribbon menu, click the Antenna button () to connect an antenna to the Tx-1 (Lo-VHF) Hopping radio.

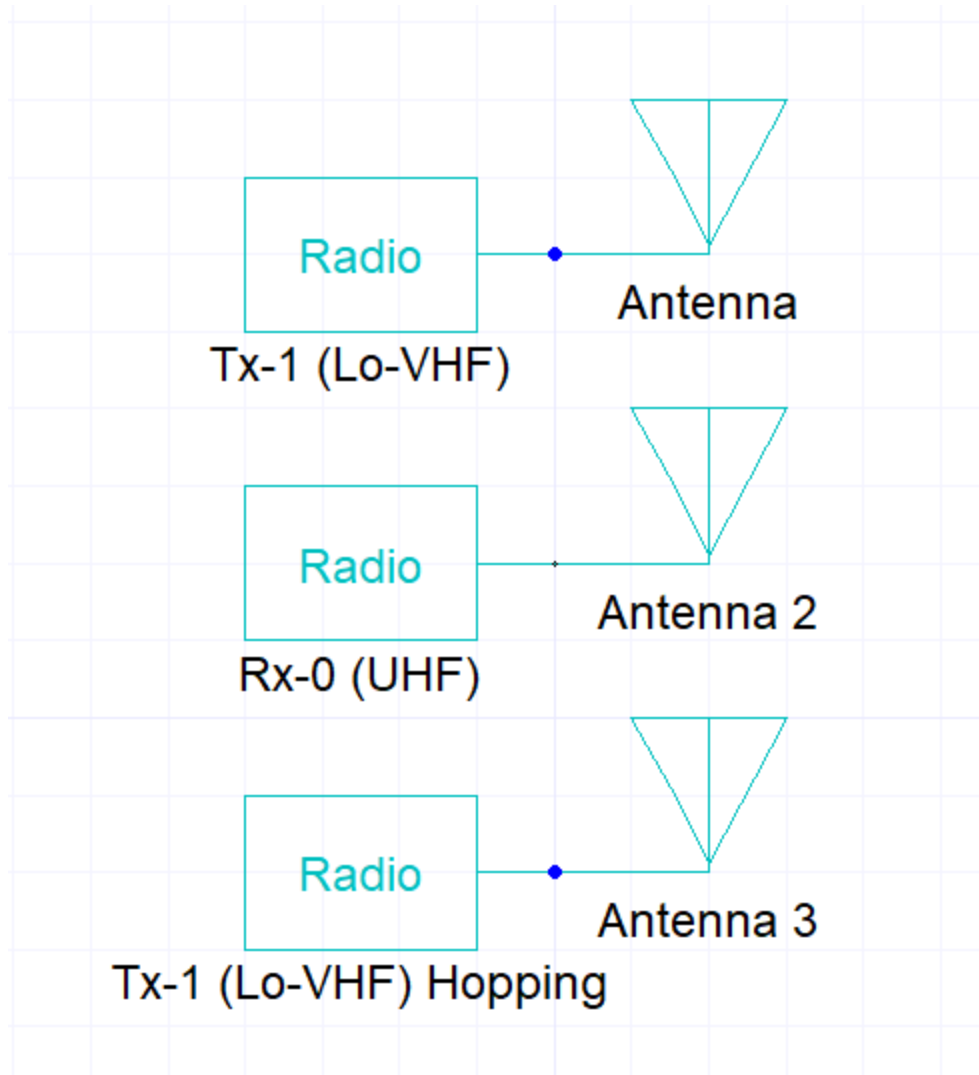

Next, we will modify the Rx radio's sampling. Open the Rx-0 (UHF) Radio's Configuration dialog and select the Sampling node. In the Sampling node's property panel, set the parameters as shown below.

Sampling Type Uniform Sampling

Specify Percentage False

Max # Channels/Range/Band 1000

Total Tx Channels 0

Total Rx Channels 21

▼ Frequency Ranges

Min (MHz)	Max (MHz)
470	490

Insert Row Remove Selected Rows

3 - Run the Simulation

From the **Simulation** ribbon, click the **Analyze** button.

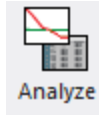

Before we run the simulation, let's view the Scenario Matrix. The project now contains 1281 Tx/Rx channel combinations, as shown below the Scenario Matrix.

Note: The [N to 1] column for the Rx-0 (UHF) receiver is still disabled because the N to 1 channel combination limit is currently too low for any N-1 analyses to occur. Moving the slider to the right will enable the [N to 1] analysis, though that is not the subject of this Tutorial. See Tutorial 3 for details on running N-1 analyses in EMIT.

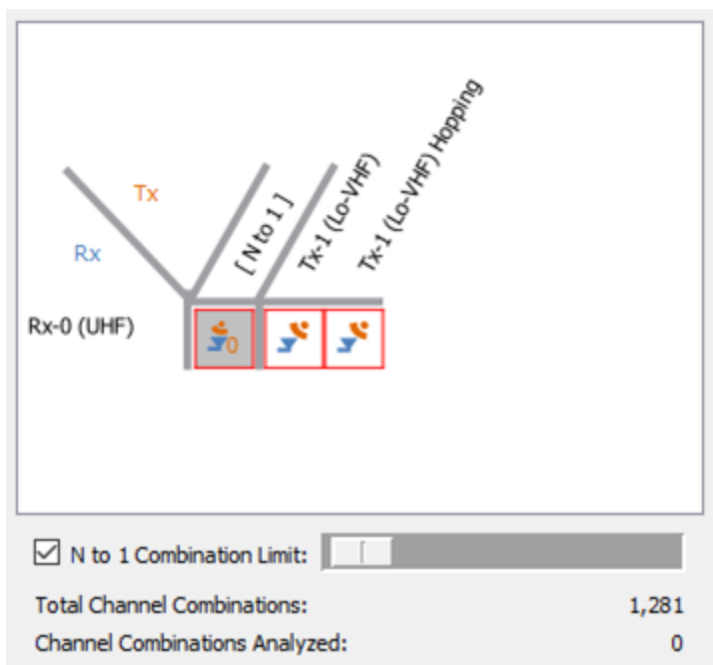

We are ready to run the analysis by selecting the Run icon (▶) above the Scenario Matrix.

The thresholds for color-coding results can be defined by the user in the Result Categorization property panel. The settings used for this example are shown below. If your settings don't match those shown below, change them now. For this scenario, we wish to flag as interference any EMI margins greater than 0 dB and any EMI margins greater than -10 dB as marginal.

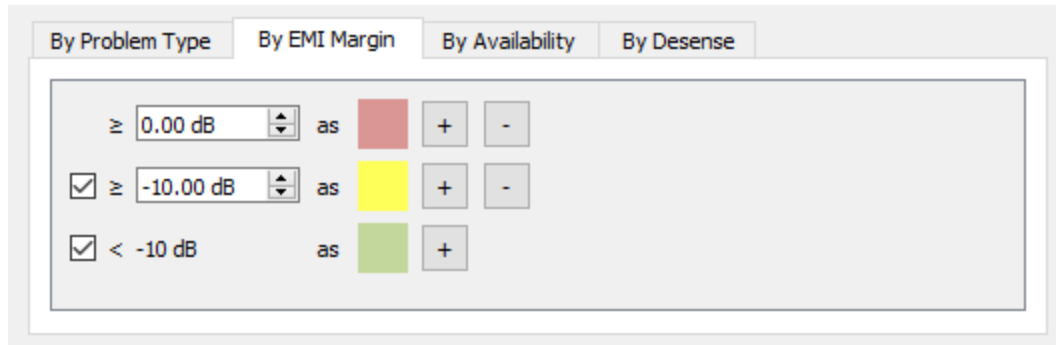

After the simulation completes, the Scenario Matrix and Scenario Details will indicate potential interference problems with a red color.

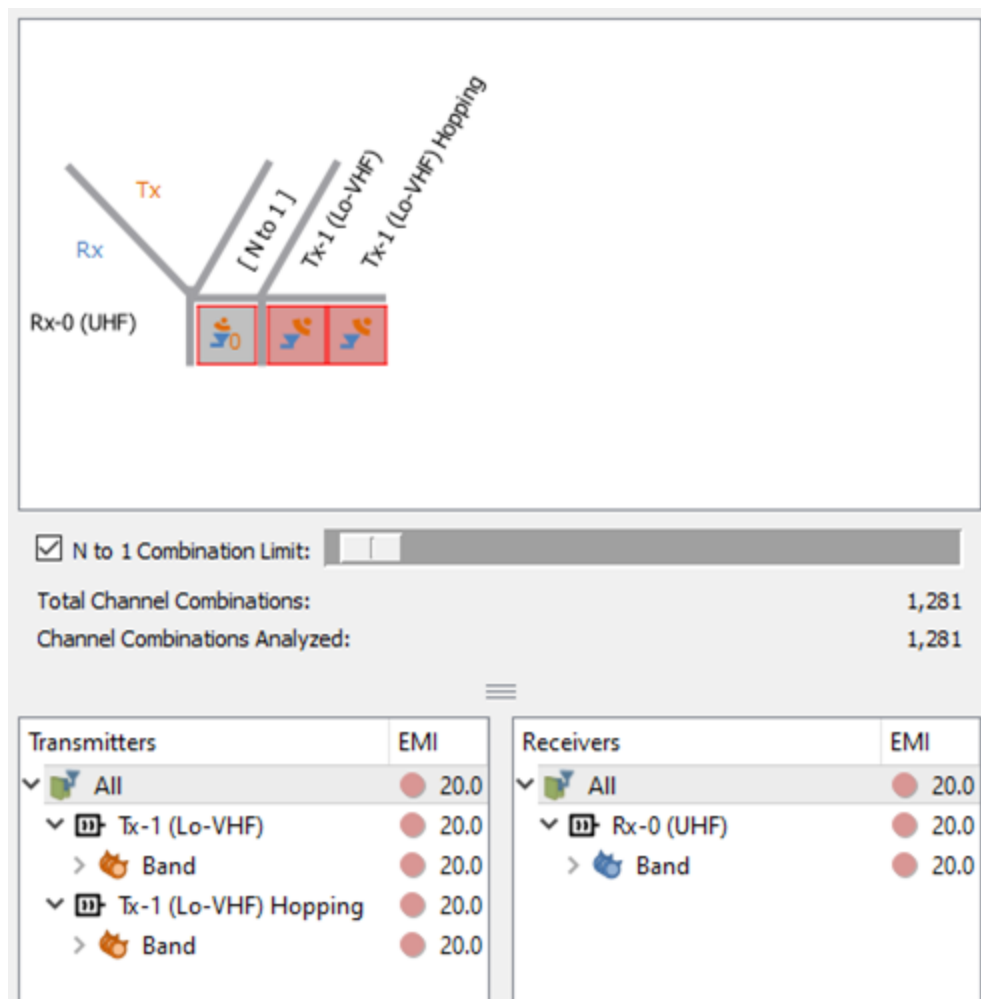

The Scenario Details display a list of the transmitters and receivers in the scenario and the worst-case interference result for each node. Although we only have a single Rx in this example, we can still explore the Scenario Details without loss of generality.

The first step is to select the Rx we wish to explore further. In this case, we have only one Rx. At this level of the Scenario Details, we see that for fixed channel operation, there is a 20 dB EMI margin indicating an interference problem. At this level, we know that there is an interference issue with this Rx, but we don't know which Tx is causing it (for multi-Tx scenarios) or what Tx/Rx channel pairs are problematic. We only know that there is at least one issue causing interference in the Rx.

Expand the Rx-0 (UHF) row in the Scenario Details to drill-down to the next level. At this level, we see a list of all the Bands defined for the radio (in this example, there is only one band). Finally, expand the Band node to display a list of all the Rx channels and the maximum EMI margins for each Rx channel.

Transmitters		EMI	Receivers		EMI
▼	All	20.0	▼	All	20.0
▼	Tx-1 (Lo-VHF)	20.0	▼	Rx-0 (UHF)	20.0
>	Band	20.0	▼	Band	20.0
▼	Tx-1 (Lo-VHF) Hopping	20.0		470 MHz	*
>	Band	20.0		471 MHz	*
				472 MHz	*
				473 MHz	*
				474 MHz	*
				475 MHz	*
				476 MHz	*
				477 MHz	*
				478 MHz	*
				479 MHz	*
				480 MHz	*
				481 MHz	*
				482 MHz	*
				483 MHz	*
				484 MHz	*
				485 MHz	*
				486 MHz	*
				487 MHz	*
				488 MHz	*
				489 MHz	*
				490 MHz	*

Note:

EMIT does not permanently store the EMI margin for the individual channels, so these may temporarily appear with an asterisk in the EMI column. If a band pair is selected in the Scenario Details, EMIT will compute and cache the channel level results until the [Result Cache](#) limit is reached.

To display the channel level EMI margins, you must also select a Tx Band or Channel in the Scenario Details. Drill-down on the transmitter side of the Scenario Details and select the Band for the Tx-1 (Lo- VHF) radio. After the band is selected, the Receivers side of the Scenario Details will update to show the channel level EMI margins for the two bands selected.

Transmitters		EMI	Receivers		EMI
▼ All		20.0	▼ All		20.0
▼ Tx-1 (Lo-VHF)		20.0	▼ Rx-0 (UHF)		20.0
▼ Band		20.0	▼ Band		20.0
30 MHz		-20.0	470 MHz		20.0
31 MHz		-20.0	471 MHz		-20.0
32 MHz		-20.0	472 MHz		20.0
33 MHz		-20.0	473 MHz		-20.0
34 MHz		-20.0	474 MHz		20.0
35 MHz		-20.0	475 MHz		-20.0
36 MHz		-20.0	476 MHz		20.0
37 MHz		-20.0	477 MHz		20.0
38 MHz		-20.0	478 MHz		-20.0
39 MHz		-20.0	479 MHz		-20.0
40 MHz		-20.0	480 MHz		20.0
41 MHz		-20.0	481 MHz		-20.0
42 MHz		-20.0	482 MHz		-20.0
43 MHz		-20.0	483 MHz		20.0
44 MHz		-20.0	484 MHz		-20.0
45 MHz		-20.0	485 MHz		-20.0
46 MHz		-20.0	486 MHz		20.0
47 MHz		20.0	487 MHz		-20.0
48 MHz		20.0	488 MHz		20.0
49 MHz		20.0	489 MHz		-20.0
50 MHz		-20.0	490 MHz		20.0
51 MHz		-20.0			
52 MHz		-20.0			
53 MHz		20.0			
54 MHz		20.0			
55 MHz		-20.0			
56 MHz		-20.0			
57 MHz		-20.0			
58 MHz		-20.0			
59 MHz		20.0			

The Scenario Details clearly shows that quite a few of the Rx channels experience interference (e.g. 470, 472, 474, 480 MHz, etc) and we can use EMIT's availability metric to determine the percentage of channels without interference. In the Analysis dialog, select the Availability icon (



) to toggle the availability metric. The Scenario Details will automatically update to show a

percentage next to each Band or Channel. This quickly shows that while the max EMI margin for the Band is +20 dB, only 1% of the channel combinations result in interference.

Transmitters		Avail	Receivers		Avail
▼	All	*	▼	All	*
▼	Tx-1 (Lo-VHF)	*	▼	Rx-0 (UHF)	*
▼	Band	99 %	▼	Band	99 %
	30 MHz	100 %		470 MHz	98 %
	31 MHz	100 %		471 MHz	100 %
	32 MHz	100 %		472 MHz	98 %
	33 MHz	100 %		473 MHz	100 %
	34 MHz	100 %		474 MHz	98 %
	35 MHz	100 %		475 MHz	100 %
	36 MHz	100 %		476 MHz	98 %
	37 MHz	100 %		477 MHz	98 %
	38 MHz	100 %		478 MHz	100 %
	39 MHz	100 %		479 MHz	100 %
	40 MHz	100 %		480 MHz	94 %
	41 MHz	100 %		481 MHz	100 %
	42 MHz	100 %		482 MHz	100 %
	43 MHz	100 %		483 MHz	98 %
	44 MHz	100 %		484 MHz	100 %
	45 MHz	100 %		485 MHz	100 %
	46 MHz	100 %		486 MHz	98 %
	47 MHz	95 %		487 MHz	100 %
	48 MHz	95 %		488 MHz	98 %
	49 MHz	95 %		489 MHz	100 %
	50 MHz	100 %		490 MHz	96 %
	51 MHz	100 %			
	52 MHz	100 %			
	53 MHz	95 %			
	54 MHz	95 %			
	55 MHz	100 %			
	56 MHz	100 %			
	57 MHz	100 %			
	58 MHz	100 %			
	59 MHz	95 %			

The availability metric is extremely useful for developing frequency plans. Scrolling through the list of transmit channels in the Scenario Details shows that many of the Tx Channels have 100%

availability, i.e., they do not cause interference. Thus, to eliminate the interference, one could simply develop a frequency plan that only operates on the channels with 100% availability.

You'll also notice that all availabilities (even those <100%) are green. This is because we are still using EMIT's default thresholds. If you go to the **By Availability** tab of the Result Categorization window, you can modify these thresholds. Let's say this is a high priority link and requires virtually no interference.

We can set the thresholds below and flag channels with even the slightest bit of interference.

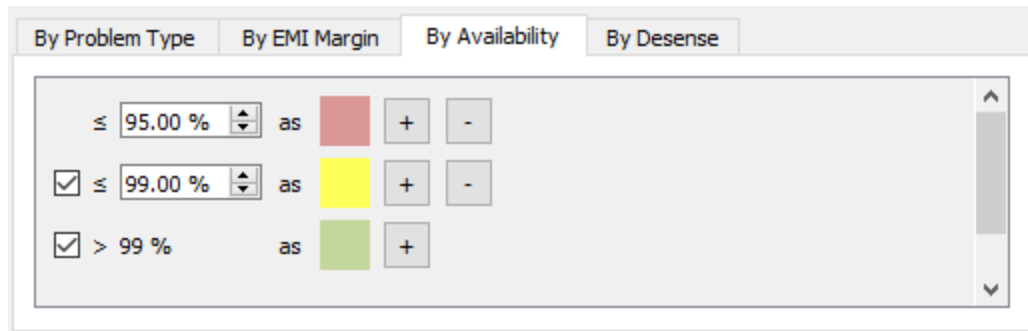

Transmitters		Avail	Receivers		Avail
▼ All		*	▼ All		*
▼ Tx-1 (Lo-VHF)		*	▼ Rx-0 (UHF)		*
▼ Band		99 %	▼ Band		99 %
30 MHz		100 %	470 MHz		98 %
31 MHz		100 %	471 MHz		100 %
32 MHz		100 %	472 MHz		98 %
33 MHz		100 %	473 MHz		100 %
34 MHz		100 %	474 MHz		98 %
35 MHz		100 %	475 MHz		100 %
36 MHz		100 %	476 MHz		98 %
37 MHz		100 %	477 MHz		98 %
38 MHz		100 %	478 MHz		100 %
39 MHz		100 %	479 MHz		100 %
40 MHz		100 %	480 MHz		94 %
41 MHz		100 %	481 MHz		100 %
42 MHz		100 %	482 MHz		100 %
43 MHz		100 %	483 MHz		98 %
44 MHz		100 %	484 MHz		100 %
45 MHz		100 %	485 MHz		100 %
46 MHz		100 %	486 MHz		98 %
47 MHz		95 %	487 MHz		100 %
48 MHz		95 %	488 MHz		98 %
49 MHz		95 %	489 MHz		100 %
50 MHz		100 %	490 MHz		96 %
51 MHz		100 %			
52 MHz		100 %			
53 MHz		95 %			
54 MHz		95 %			
55 MHz		100 %			
56 MHz		100 %			
57 MHz		100 %			
58 MHz		100 %			
59 MHz		95 %			

If you select one of the Rx channels (e.g. 470 MHz) with availability = 98% and then toggle back to the EMI Margin metric (click the ), you'll notice that only one of the Tx channels (47 MHz) interferes with that channel. Simply avoiding operating on that channel combination would eliminate the interference.

While we now have an acceptable mitigation strategy, let's continue to investigate the specific cause(s) of the interference problems. Toggle the Scenario Details back to the EMI Margin results by clicking the  icon and select the 480 MHz Rx channel. The EMI margins on the Tx side of the Scenario Details will instantly update to reflect the EMI margin that each specific Tx channel causes for the specific 480 MHz Rx channel. Scrolling through the list, we see that there are 3 Tx channels that cause interference for the 480 MHz Rx Channel: 48 MHz, 60 MHz, and 80 MHz.

Transmitters	EMI	Receivers	EMI
48 MHz	20.0	All	20.0
49 MHz	-20.0	Rx-0 (UHF)	20.0
50 MHz	-20.0	Band	20.0
51 MHz	-20.0	470 MHz	20.0
52 MHz	-20.0	471 MHz	-20.0
53 MHz	-20.0	472 MHz	20.0
54 MHz	-20.0	473 MHz	-20.0
55 MHz	-20.0	474 MHz	20.0
56 MHz	-20.0	475 MHz	-20.0
57 MHz	-20.0	476 MHz	20.0
58 MHz	-20.0	477 MHz	20.0
59 MHz	-20.0	478 MHz	-20.0
60 MHz	20.0	479 MHz	-20.0
61 MHz	-20.0	480 MHz	20.0
62 MHz	-20.0	481 MHz	-20.0
63 MHz	-20.0	482 MHz	-20.0
64 MHz	-20.0	483 MHz	20.0
65 MHz	-20.0	484 MHz	-20.0
66 MHz	-20.0	485 MHz	-20.0
67 MHz	-20.0	486 MHz	20.0
68 MHz	-20.0	487 MHz	-20.0
69 MHz	-20.0	488 MHz	20.0
70 MHz	-20.0	489 MHz	-20.0
71 MHz	-20.0	490 MHz	20.0
72 MHz	-20.0		
73 MHz	-20.0		
74 MHz	-20.0		
75 MHz	-20.0		
76 MHz	-20.0		
77 MHz	-20.0		
78 MHz	-20.0		
79 MHz	-20.0		
80 MHz	20.0		

Select the row in the Scenario Details corresponding to the 60 MHz Tx channel. The plot marker and label in the Result Plot quickly identify that the interference is due to the 8th harmonic of the Tx falling in the Rx channel of 480 MHz ($8 \times 60 = 480$ MHz).

Similarly, selecting the 48 MHz and 80 MHz Tx channels in the Scenario Details will show that the interference due to those channels is also due to harmonics that fall within the 480 MHz Rx channel. To quickly see if there is any interference in this Rx Band that is not due to harmonics, select the Rx Band in the Scenario Details.

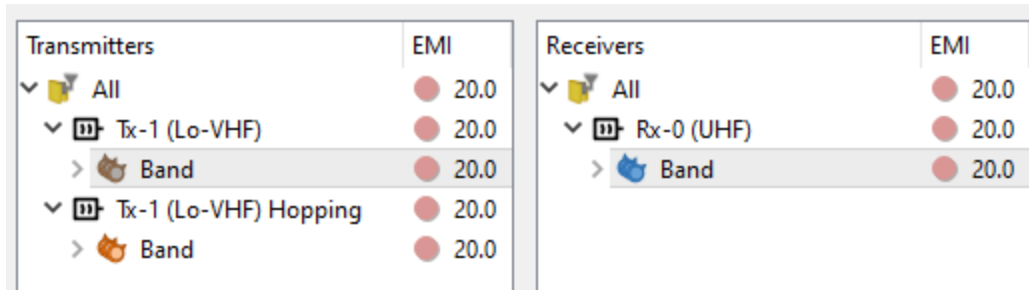

Next, in the upper-right corner of the Analysis dialog, select the **By Problem Type** tab.. Under the Rx In-Channel category, deselect the **Tx Harmonics/Spurious** option. This will remove (via post-processing) any interference that is due to transmitter harmonics or spurs falling in the Rx's tuned channel from the results views (Scenario Matrix, Scenario Details, Result Plots, and Interaction Diagram).

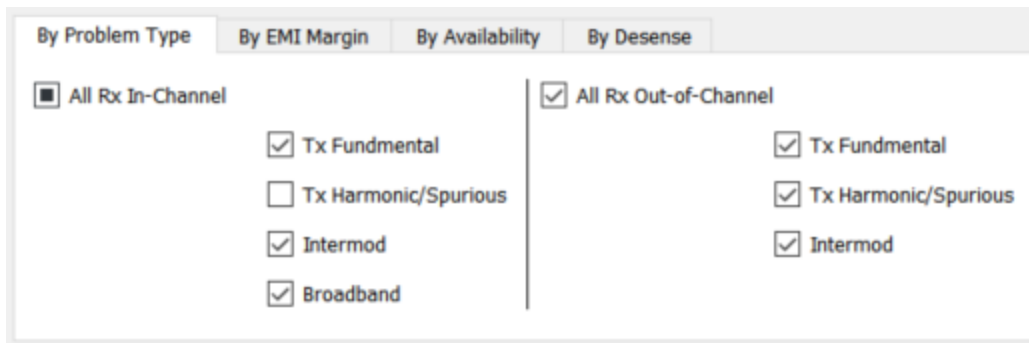

The worst-case EMI margin is now -20 dB and is due to the out-of-band fundamental.

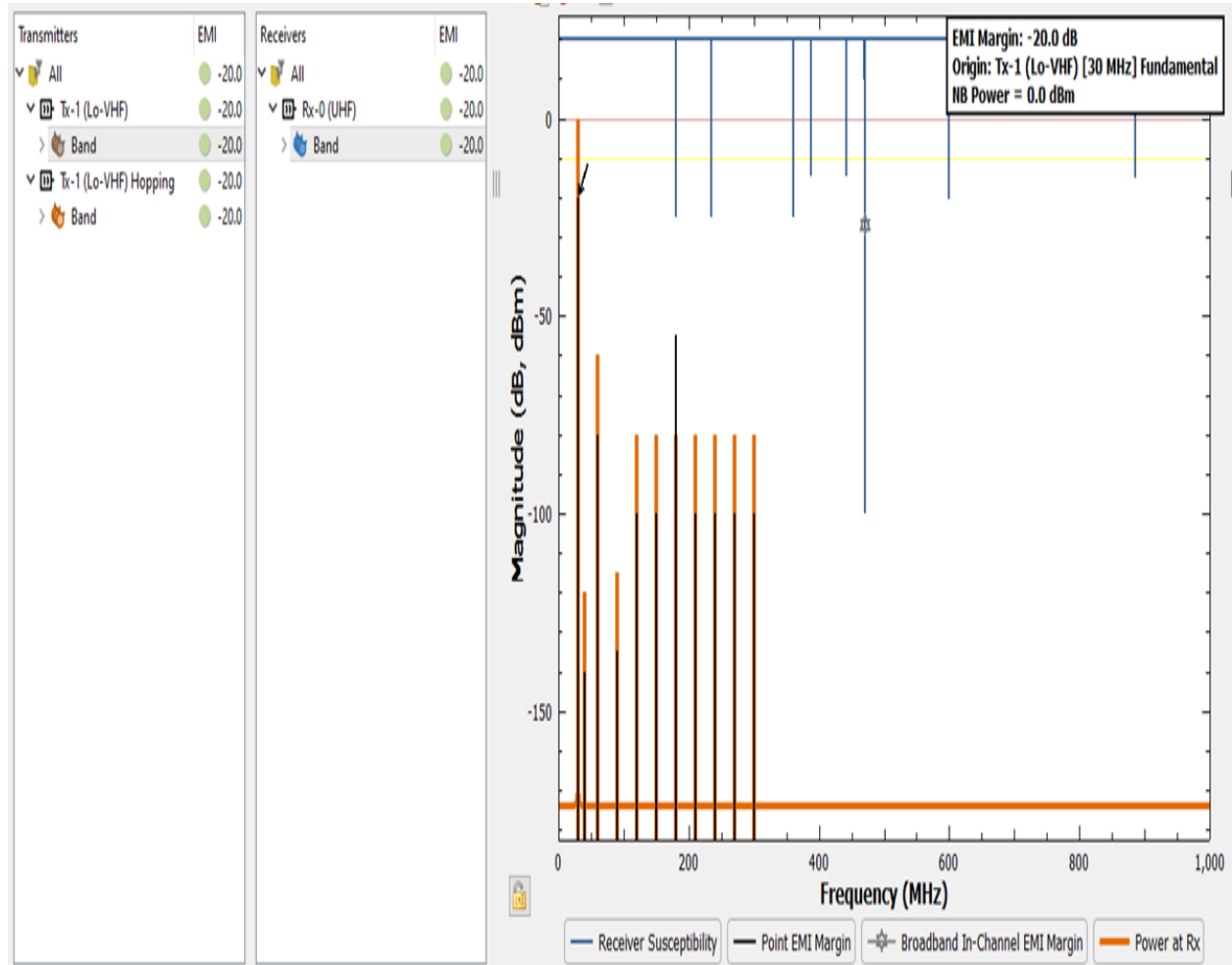

Finally, let's look at the results for our "Frequency Hopping" radio (toggle the Tx/Harmonic/Spurious problems back on). In the Scenario Details, select the Tx-1 (Lo-VHF) Hopping radio. Drill-down to display its channels so we can inspect them more thoroughly. Note that the Band contains a random list of frequencies, as seen below.

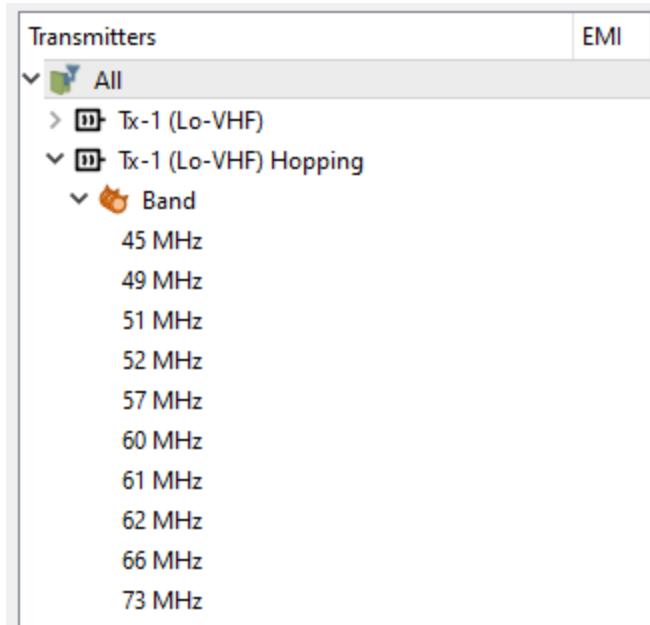

The parameters of the random list of frequencies are set by the Sampling properties of the radio. The frequency range limits the possible channels to the 30-80 MHz subrange (remember, the Band is defined to operate from 30-100 MHz) and the Max # Channels/Band specifies that we want 10 channels for each range. The last parameter here is the Seed, which allows the random simulation to be repeated since the same seed will always result in the same channels selected.

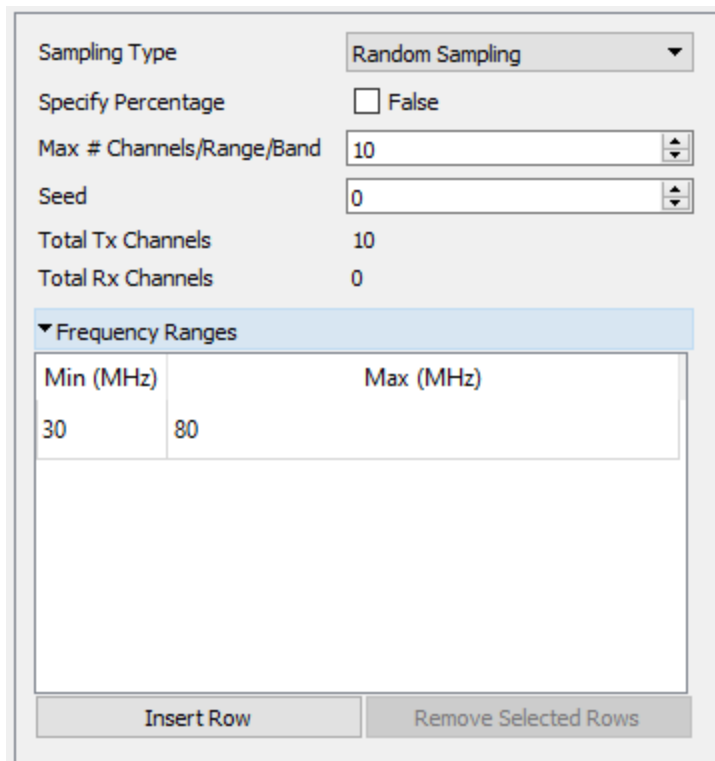

Close the Analysis window to return to the schematic view. Open the Configuration dialog box for the Tx-01 (Lo-VHF) Hopping radio and select the Sampling node. Change the seed to 20 and click the X to close the dialog box. Click the Analyze button in the ribbon to reopen the results dialog box. In the Scenario Details, select the Tx-1 (Lo-VHF) Hopping radio and expand the Band node. The channel list should appear as below.

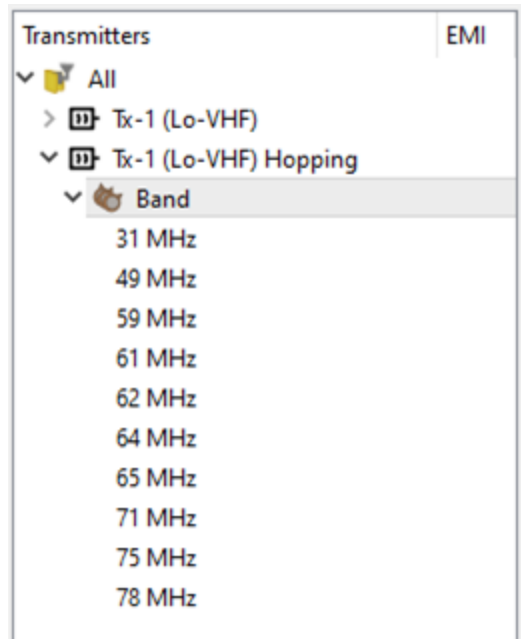

Next, let's further modify our Tx-1 (Lo-VHF) Hopping Sampling by setting multiple ranges for the random channel selection. Again, close the Analysis window, open the Configuration dialog for the Tx-1 (Lo-VHF) Hopping radio, and set the parameters as shown below.

The screenshot shows the EMIT Analysis dialog box with the following settings:

- Sampling Type: Random Sampling
- Specify Percentage: False
- Max # Channels/Range/Band: 5
- Seed: 20
- Total Tx Channels: 15
- Total Rx Channels: 0

The "Frequency Ranges" section is expanded, showing a table with three rows:

Min (MHz)	Max (MHz)
30	40
50	70
80	100

At the bottom of the dialog, there are two buttons: "Insert Row" and "Remove Selected Rows".

Reopen the Analysis dialog and note the changes in the Scenario Details. There should be 3 ranges, each with 5 random channels in each range.

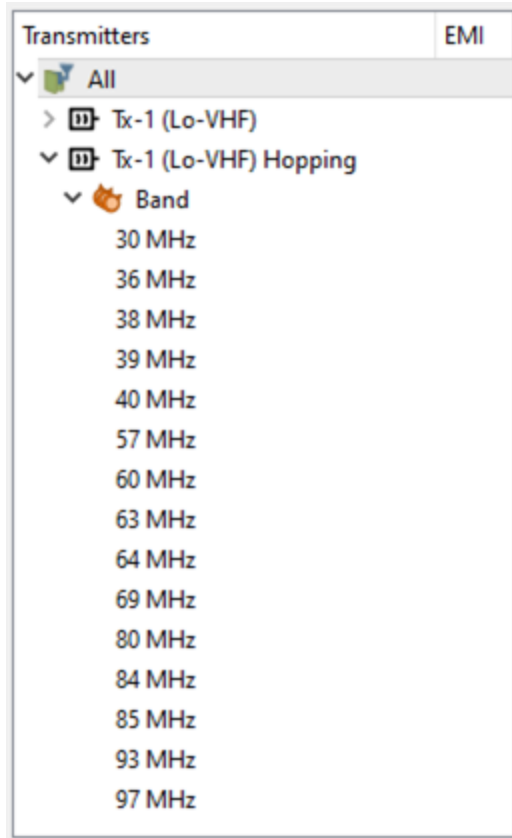

Finally, to show the reproducibility of the random analysis mode, set the Tx-1 (Lo-VHF) Hopping Sampling's properties back to their initial settings as shown below.

The screenshot shows a configuration window with the following settings:

- Sampling Type: Random Sampling
- Specify Percentage: False
- Max # Channels/Range/Band: 10
- Seed: 0
- Total Tx Channels: 10
- Total Rx Channels: 0

Under the "Frequency Ranges" section, there is a table with two columns: "Min (MHz)" and "Max (MHz)".

Min (MHz)	Max (MHz)
30	80

Buttons at the bottom: "Insert Row" and "Remove Selected Rows".

Again, reopen the Analysis window, select the Tx-1 (Lo-VHF) Hopping radio in the Scenario Details list, and expand the Band node. The original frequency list that produced the green results above should now be displayed in the Scenario Details.

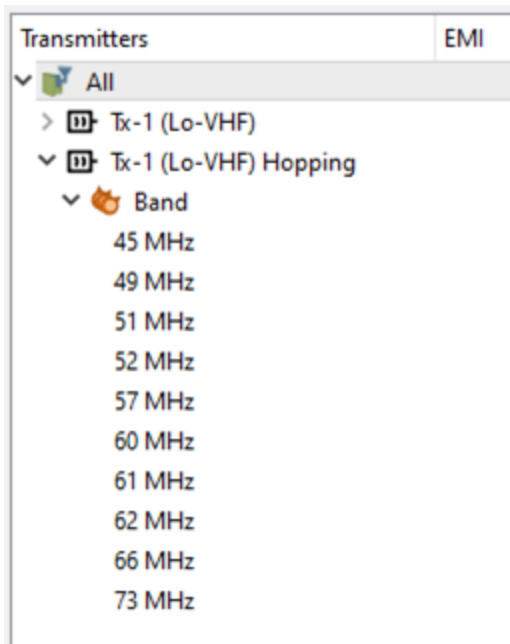

At this point, save your project and experiment a bit with the Results Categorization filters to examine other Tx/Rx channel pairs in the various hopping and non-hopping samplings to get a feel for operation of this important EMIT feature.